



THE GENERAL RADIO

Experimenter

Single-Range RC Audio Oscillator ▶



RC-OSCILLATOR
Synchronization



VOLUME 41 • NUMBER 2 / FEBRUARY 1967



IET LABS, INC in the GenRad tradition
534 Main Street, Westbury, NY 11590

TEL: (516) 334-5959 • (800) 899-8438 • FAX: (516) 334-5988

www.ietlabs.com

the Experimenter

© 1967 — General Radio Company, West Concord, Mass., USA

Published monthly by the General Radio Company

THIS ISSUE

	Page
RC-Oscillator Synchronization.....	3
10 Hz to 50 kHz without Range Changing.....	12
Harmonic Bridge Uses RC-Oscillator Synchronization.....	15
A Preamp for Use with Bridge Detectors.....	17
Synchrometer with 1-2-4-8 Code.....	19
Quantity Prices for Enlarged Smith Charts.....	19
Experimenter Index.....	20

GENERAL RADIO COMPANY

West Concord, Massachusetts 01781

* NEW ENGLAND

22 Baker Avenue
West Concord, Massachusetts 01781

* METROPOLITAN NEW YORK

845 Broad Avenue
Ridgefield, New Jersey 07657

PHILADELPHIA

Fort Washington Industrial Park
Fort Washington, Pennsylvania 19034

* WASHINGTON and BALTIMORE

Post Office Box 1160
11420 Rockville Pike
Rockville, Maryland 20850

ORLANDO

113 East Colonial Drive
Orlando, Florida 32801

SYRACUSE

Pickard Building, East Molloy Rd.
Syracuse, New York 13211

CLEVELAND

5579 Pearl Road
Cleveland, Ohio 44129

* CHICAGO

6605 West North Avenue
Oak Park, Illinois 60302

* DALLAS

2600 Stemmons Freeway, Suite 210
Dallas, Texas 75207

* LOS ANGELES

1000 North Seward Street
Los Angeles, California 90038

SAN FRANCISCO

Post Office Box 1389
626 San Antonio Road
Mountain View, California 94040

MONTREAL

1255 Laird Boulevard
Town of Mt. Royal, Quebec, Canada

* TORONTO

99 Floral Parkway
Toronto 15, Ontario, Canada

* Repair services are available at these offices

GENERAL RADIO COMPANY (OVERSEAS), 8008 Zurich, Switzerland

GENERAL RADIO COMPANY (U.K.) LIMITED, Bourne End, Buckinghamshire, England

REPRESENTATIVES IN PRINCIPAL OVERSEAS COUNTRIES



IET LABS, INC in the GenRad tradition

534 Main Street, Westbury, NY 11590

TEL: (516) 334-5959 • (800) 899-8438 • FAX: (516) 334-5988

www.ietlabs.com

RC-OSCILLATOR

Synchronization

Four General Radio oscillators — the Types 1309,¹ 1310,² 1311,³ and 1313 (see page 12) — are equipped with an auxiliary connector that serves several very useful purposes. Used as an input connector, it allows the oscillator frequency to be locked to an external signal while simultaneously filtering that signal. Used as an output connector, it provides a constant-amplitude synchronizing signal for an oscilloscope or counter. Inasmuch as this "synchronizing jack" is a fairly recent development in oscillator design (originated by GR in 1962), a summary of synchronization characteristics and of typical applications may help users of these instruments get even more out of them.

¹ R. E. Owen, "All-Solid-State, Low-Distortion Oscillator," *General Radio Experimenter*, March 1966.

² R. E. Owen, "A Modern, Wide-Range RC Oscillator," *General Radio Experimenter*, August 1965.

³ R. G. Fulks, "High-Performance, Low-Cost Audio Oscillator with Solid-State Circuitry," *General Radio Experimenter*, August-September 1962.

CHARACTERISTICS

Frequency-Synchronization Characteristics

When a signal is injected through the auxiliary connector into the active RC-oscillator circuit and the oscillator is tuned within a certain range of this signal, normal oscillations cease, and the oscillator appears to oscillate stably at the injected-signal frequency. The range of frequencies over which this locking takes place is a linear function of the amplitude of the component of the input signal to which the oscillator is locked.

General Radio RC oscillators are designed so that each has a frequency lock range of $\pm 3\%$ for each volt input (see Figure 1). Inputs of up to 10 volts can be used without altering the operation. As Table 1 shows, the 1313-A oscillator is an exception. It is not of

TABLE 1. SYNCHRONIZATION CHARACTERISTICS

Oscillator Type	INPUT CHARACTERISTICS			OUTPUT CHARACTERISTICS		
	Lock Range %/volt	Phase between input and output	Gain Factor	Open-Circuit Output - volts	Output Impedance - $k\Omega$	Phase with respect to main output
1309	± 3	$180 \pm 90^\circ$	0.47 at 5-V output	1.4	12	0°
1310	± 3	$0 \pm 90^\circ$	0.28 at 20-V output	0.8	27	180°
1311	± 3	$180 \pm 90^\circ$	0.94 at 100-V output	1.0	4.7	0°
1313	± 1 to ± 40	$180 \pm 90^\circ$	-	0.7	330	0°

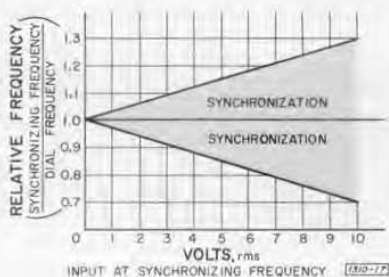

Figure 1. Locking range vs input voltage for Types 1309, 1310, and 1311 Oscillators.

the conventional Wien-bridge type, and its locking-range sensitivity varies appreciably over its frequency range.

The oscillator maintains synchronization if either the oscillator dial frequency or the synchronizing frequency is changed, within the lock range. However, a time constant of about one second is associated with the synchronization mechanism. Thus, if the amplitude or frequency of the synchronizing signal or the dial setting of the oscillator is quickly changed, transient changes in amplitude and phase will occur for a few seconds before the oscillator returns to steady-state synchronization.

This time constant is caused by the thermistor amplitude regulator readjusting to the different operating conditions. The thermistor is sensitive to changes in average values of frequency or amplitude only when the averaging time is in the order of seconds. Hence, frequency-modulated and amplitude-modulated synchronizing signals, whose average values of frequency and amplitude are constant over a period of a second or less, are not affected by this time constant. They are affected by the equivalent time constant of the

filter characteristic discussed in the next section.

For slow changes in frequency or amplitude, the lock range and the capture range are the same; i.e., the frequency or amplitude at which the oscillator goes from the synchronized state to the unsynchronized state is the same as that at which it goes from the unsynchronized state to the synchronized state.

There is a phase difference between the input synchronizing signal and the oscillator output, which depends upon the frequency's relation to the oscillator dial frequency, as Figure 2 shows. Note that the phase shift is a function of amplitude, since the lock range is a function of amplitude. Hence, the constancy of the phase shift at other than 0° depends on the amplitude stability of the input signal as well as on the frequency stability of the oscillator. As a practical matter, the useful range of phase shifts is limited to somewhat less than $\pm 90^\circ$ because of the steepness of the curve near the limits of the lock range. The data in Figure 2 are displaced by 180° for the 1309, 1311, and 1313 Oscillators because they do not have a phase-inverting output stage.

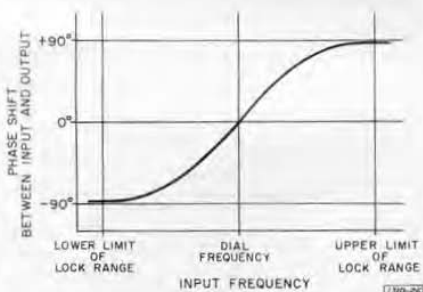

Figure 2. Phase shift relative to input frequency (and amplitude).

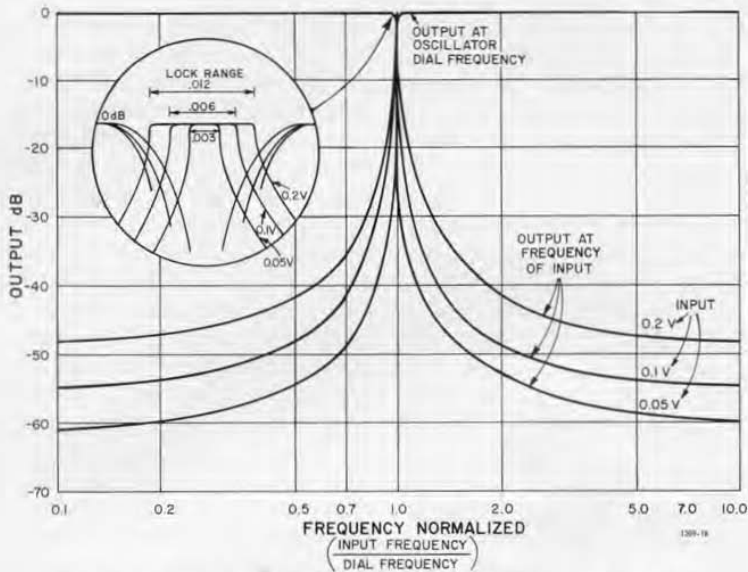

Figure 3. Response of a 1309 Oscillator for three different input-voltage levels.

Frequency-Selective Amplification Characteristics

When the output of the oscillator is locked to the input synchronizing signal, the oscillator is not oscillating in the conventional sense but is, in fact, producing an amplitude-stabilized, frequency-selective regeneration of the input signal. The result is that all the frequency spectrum of the synchronizing signal appears in the output, although most of it is greatly attenuated. Figure 3 shows the response of a 1309-A for three different input-voltage levels and for frequencies up to ten times and down to one tenth of the oscillator dial frequency. The oscillator output at both the input frequency and dial frequency is given, except within the lock range where the dial frequency oscillations stop, as seen in the magnified portion of Figure 3. The apparent increase in

the Q of the response as the input level decreases is due to the fact that the output is constant within the lock range (the normal output level of the oscillator) regardless of input, while at all other frequencies it is a direct function of the input (doubling the input voltage increases the output by 6 dB).

Figure 3 is a family of curves for different input voltages, with the output plotted in dB relative to the normal oscillator output, for one particular oscillator. The single curve of Figure 4, together with Table 1, can be used to calculate the response for any input level with any GR oscillator. Figure 4 is a plot of the voltage gain versus frequency for an equal-element Wien-bridge oscillator between its synchronization input and the output. Note that for frequencies distant from

the dial frequency the gain asymptotically approaches 2.0. In each oscillator this gain is modified by the resistive input divider and output amplifier. Table 1 gives the appropriate multiplying gain factor for the four GR oscillators set for maximum output voltage.

For example, the voltage amplification between the input synchronization jack on the 1309 and the full output, at twice the dial frequency, is $(0.47) (4.5) = 2.1$. Thus, if there were a 0.1-volt input at twice the dial frequency, there would be $(0.1) (2.1) = 0.21$ volt in the unattenuated output, or $\frac{(0.21) \text{ volt} (100)}{5.0 \text{ volts}} = 4.2\%$ of the output at the dial frequency, regardless of the amount of output attenuation.

The input impedance of the synchronization connection is the same as

the output impedance listed in Table 1, for frequencies outside the lock range. At the synchronizing frequency the input impedance, in general, is complex and can vary over a wide range, including negative values because the connection is also a source at the synchronizing frequency.

Output Characteristics

Since the injection-synchronization input connects to a resistive divider across the output of the oscillator, it is also an output. This output can be valuable because it is of constant amplitude regardless of the main-output amplitude, which may be reduced by the attenuator. The open-circuit output voltage and output impedance are given for each of the oscillators in Table 1. In each case, the amplitude is sufficient to trigger an oscilloscope or a counter. However, note that the

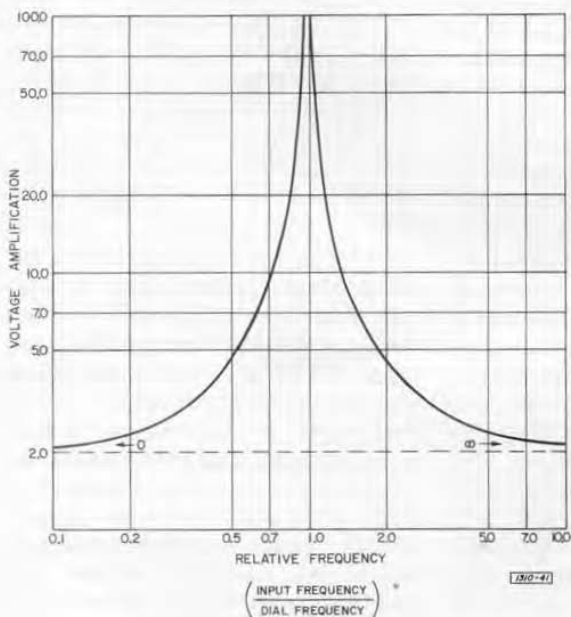

Figure 4. Voltage gain between unattenuated sync input and unattenuated output for a Wien-bridge oscillator.

output impedances are higher than are usually expected from a source. At high frequencies the output may be reduced by the capacitive loading of connecting cables.

Table 1 also gives the phase relation between the synchronization jack and the main output. Because the 1310 Oscillator output is 180° out of phase, an output balanced with respect to ground can be obtained.

This output is always a sine wave, so that on the 1309 and 1313 Oscillators simultaneous sine- and square-wave outputs are available.

APPLICATIONS

The various functions of the synchronizing jack are distinct but do exist simultaneously and can be used in complementary ways. The following applications are among the more obvious and show, with circuits and sample calculations, how the above data can be used.

Locking to a Stable Source

An oscillator with injection-synchronization capability can obviously be locked to a more accurate frequency reference to increase its long-term frequency stability. The advantages of this are many. The frequency selectivity of the oscillator can appreciably reduce the hum, noise, and distortion in the source. It will provide amplification, since less than one volt into a high impedance is necessary for locking, and yet up to 100 volts at low impedances is available in the output. The long-term amplitude stability will be the same as that of the normal oscillator, regardless of the long-term fluctuations in the input. Input-amplitude changes of 20 dB are easily suppressed in the output.

The oscillator isolates the reference source from changes in load and from the addition of spurious signals. Also, with the 1310 and 1311 Oscillators, it is possible to short-circuit the output without increasing distortion.

If the oscillator is locked to one of the harmonics of the source, it functions as a precision frequency multiplier. The accuracy and the long-term stability of the submultiple source are maintained, and the output is sinusoidal.

As an example, Figure 5(a) is the frequency spectrum of the output of a sinusoidal 1-kHz standard frequency derived by division from a crystal frequency standard. Note the 120-Hz hum, the noise close to the fundamental, and the large amount of harmonic distortion. Figure 5(b) is the output of a 1310 Oscillator locked to the same source. The distortion is reduced to almost the normal level of the oscillator, the hum is more than 80 dB below the signal, the noise is noticeably reduced, and yet the long-term frequency stability is the same as that of the reference source. The short-term stability, like the distortion, cannot be made better than that normally existing in the oscillator.

Whenever the synchronized oscillator is used for filtering, as above, the input voltage can be adjusted to an optimum level. The voltage should be high to provide a locked frequency range wide enough so that the oscillator will not drift out of lock, and yet low enough to reject the unwanted signals. Suppose that in the example it is desired to minimize the second harmonic in the oscillator output. The typical long-term stability of the 1310 at 1 kHz is 0.03% after warm-up;

therefore, a lock range of $\pm 0.12\%$ should provide a sufficient margin to ensure that the oscillator will always remain locked. This would require an input at 1 kHz of $\frac{0.12\%}{3.0\%/volt} = 0.04$ volt. The second harmonic in this signal is 26 dB below the desired 1-kHz fundamental (5.0%). From Table 1 and Figure 4, it is found that the 1310 has a voltage gain at the second harmonic of $(4.5)(0.28) = 1.25$. Therefore, with a 0.04-volt input there would be $(1.25)(0.04)(0.05) = 0.0025$ volt of the second harmonic in the 20-volt oscillator output, or $\frac{0.0025 \text{ volt}}{20 \text{ volts}} = 0.0125\%$, re-

gardless of the output attenuator setting. This is below the amount of second-harmonic distortion normally present in the oscillator, as Figure 5(b) shows, so it is certain that the largest possible reduction of the second harmonic has been made.

Frequency-Jitter Reduction

Although the short-term frequency stability, or jitter, of the synchronized oscillator cannot be better than when it is unsynchronized, it can be better than the source to which it is locked. This is, again, because it behaves as a tracking narrow-band filter.

In Figure 6, the output frequency of a drifting, jittery 10-Hz source is

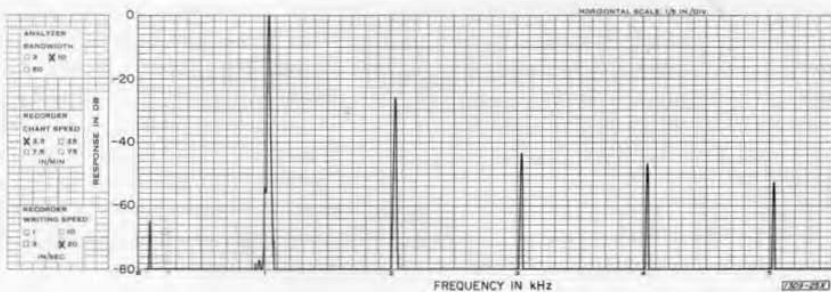

Figure 5(a). Spectrum of a typical sinusoidal 1-kHz standard frequency, derived by division from a crystal frequency standard.

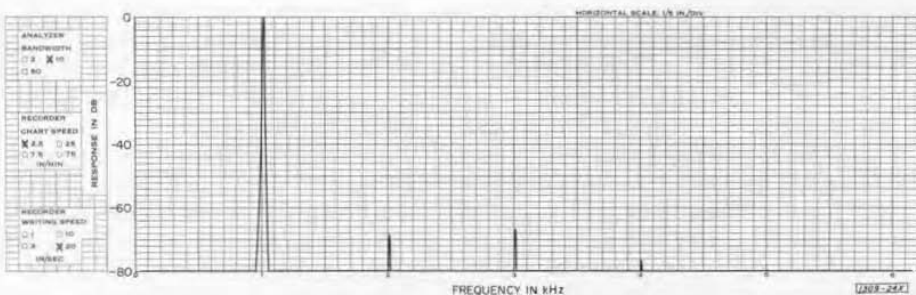

Figure 5(b). Spectrum of the output of a 1310 Oscillator synchronized with the 1-kHz standard of Figure 5(a). Note the reductions in hum, noise, and distortion.

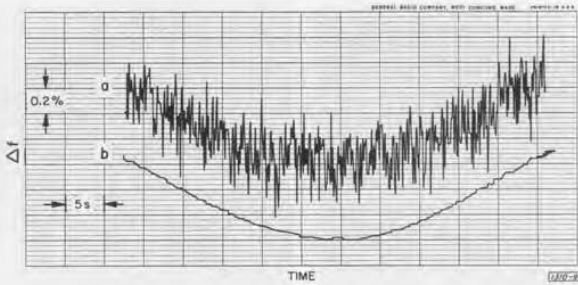

Figure 6. (a) Output frequency of a drifting, jittery 10-Hz source. (b) Output frequency of oscillator synchronized with source (a). Note that jitter is reduced while drift is tracked.

recorded along with the frequency of the output of an oscillator synchronized to that source. The filter selectivity has considerably reduced the short-term jitter, while the oscillator has remained locked onto the long-term drifting average. The low frequency of this example was used for convenience in making the graphic recordings. A reduction in jitter can be made at any frequency where the filter characteristic is sufficiently selective. The ability to track longer-term drift, however, is always limited by the approximately

one-second time constant of the locking mechanism.

Harmonic Waveform Synthesis

One of the most popular uses of the synchronized oscillator is as a sinusoidal frequency multiplier for Fourier synthesis of various waveforms. The oscillators are simply locked onto a harmonically rich waveform with the input level adjusted for sufficient suppression of the other harmonics.

Tone bursts can supply a harmonically rich signal for synchronizing. For example, if it is desired to synthesize

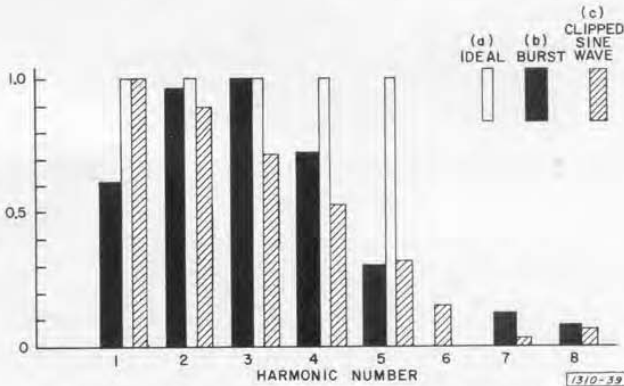

Figure 7. Spectrum of locking signal for generating waveforms with five harmonics. (a) ideal, (b) tone-burst approximation, (c) clipped sine-wave approximation.

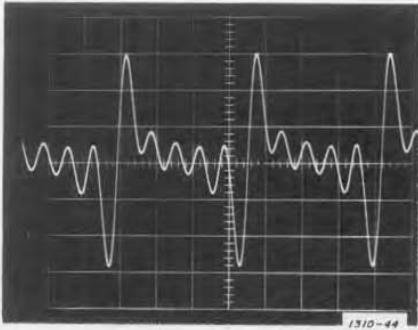

Figure 8. Ideal signal for generating waveforms with five harmonics. It is composed of equal amplitudes of the five in-phase harmonics.

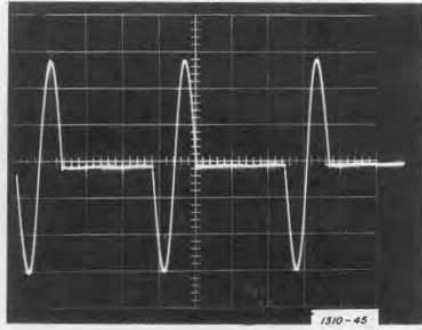

Figure 9. Tone-burst approximation to Figure 8.

pure waveforms from the first five harmonics, a waveform with the spectrum of (a) in Figure 7 would be best. This has the waveshape of Figure 8, which can be approximated by a single cycle of the third harmonic with a repetition rate of the fundamental frequency, as in Figure 9. Its spectrum, (b) in Figure 7, is quite close to ideal. This waveform is easily generated with the GR 1396 Tone-Burst Genera-

tor (see Figure 10). The spectrum of a tone burst is very good for synchronizing because it can produce a relatively flat spectrum for large harmonic numbers and because it is not frequency-sensitive.

Conventional nonlinear waveshaping methods can be used to generate a signal with a desired harmonic spectrum. If shaping techniques are used, it is helpful to recall that, for repetitive

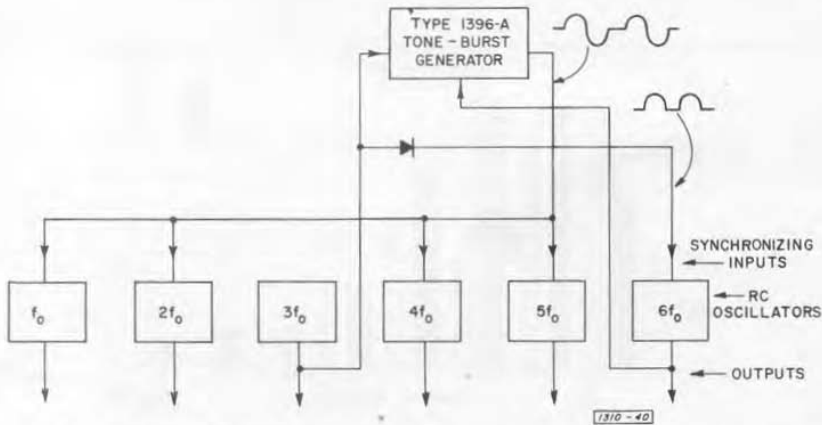

Figure 10. One method of obtaining synchronized oscillators for first six harmonics. Waveform of Figure 9 is used to lock oscillators.

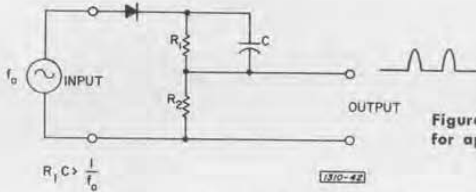

Figure 11. Sine-wave clipping circuit for approximating equal-amplitude harmonics pulses.

equal-amplitude harmonic signals, the waveform goes progressively from a smooth sine wave with one harmonic to an impulse with all harmonics. Hence, the ideal synchronizing signal is an appropriately bandwidth-limited impulse. For low harmonics this can be approximated with a clipped sine wave by means of a circuit such as that of Figure 11. For this five-harmonic example, values for R_1 and R_2 of 10 k Ω and 200 Ω , respectively, produced the waveform of Figure 12 and the spectrum of (c) in Figure 7.

As in the first application, there is an optimum input-synchronizing voltage, which provides the best combination of purity of output and lock range. In this case it usually is desirable to make the lock range large so that the phase of each harmonic can be adjusted. The phase-coherent signal of Figure 8 was generated with the equipment shown in Figure 10, and all undesired higher harmonics were more than 60 dB below the five equal-amplitude ones.

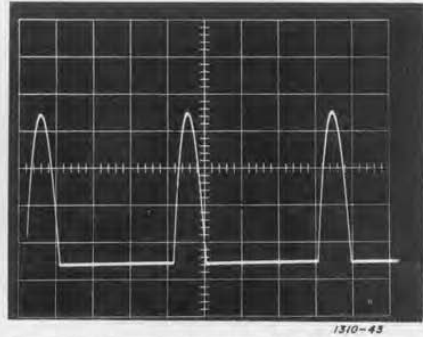

Figure 12. Clipped sine wave with the spectrum of Figure 7(c).

Phase Shifting

The synchronized oscillator can be used as a convenient, single-frequency phase shifter or time delay. Table 1, in conjunction with Figure 2, shows the range of phase shift available for each oscillator. This is particularly useful with the 1309, where the Schmitt trigger in the square-wave circuit permits generation of variable-delay pulses.

— R. E. OWEN

GENERAL RADIO RC OSCILLATORS WITH SYNCHRONIZATION

Condensed Specifications					
Oscillator Type	Frequency Range	Output Waveform	Output Voltage	Output Power	Distortion
1309	10 Hz - 100 kHz		500 μ V - 5V	10 mW	0.05%
1310	2 Hz - 2 MHz		0.1 - 20V	160 mW	0.25%
1311	50 Hz - 10 kHz in 11 steps		0-1, 3, 10, 30, 100V Transformer output	1 W	0.5%
1313	10 Hz - 50 kHz		500 μ V - 5V	10 mW	0.5%



Figure 1. Type 1313-A Oscillator.

10 Hz TO 50 kHz
WITHOUT RANGE CHANGING

For general laboratory use, the conventional decade frequency range on an RC oscillator is a good compromise between accuracy, resolution, and ease-of-setting. On the production line, however, where measurements are made in rapid succession over a wide frequency range, the necessary range switching and large return sweeps of the dial become an important disadvantage. To eliminate this problem, General Radio has developed a low-cost RC oscillator with the entire audio-frequency range covered in a single range.

The TYPE 1313-A Oscillator (Figure 1) provides sine and square waves from 10 Hz to 50 kHz. The frequency is

quickly and easily set and unambiguously indicated on a single-turn dial. There are no multipliers to use or decimal points to slip; the dial is marked the way you would say the frequency: ten kilohertz is 10 kHz, not 10,000 Hz, for example. Also, since there is no range switch, there are no range-changing transients, no fast, high-amplitude pops to rupture a voice coil or mechanical transducer. And there is no necessity for routine replacement of the range switch, as there often is with other oscillators used on production lines.

The TYPE 1313-A is in many respects similar to the popular TYPE 1309-A 10

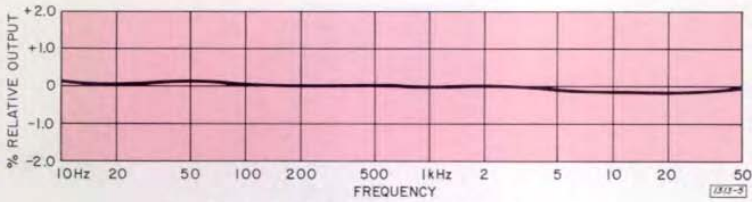

Figure 2. Typical output-vs-frequency characteristic.

Hz-100 kHz Oscillator¹. It uses the same all-silicon, all-solid-state design, except that a modified Wien Bridge expands the frequency range. The technique used is similar to that employed by Anderson in a seven-decade oscillator², but it has been refined with the aid of a digital computer.

The sine-wave output is continuously adjustable over a range of from less than 500 μ V to 5.0 volts open-circuit by means of a 60-dB step attenuator and a continuous control. The steady-

state output voltage is held within $\pm 2\%$ of its 1-kHz value over the whole dial span; it is typically even better than this, as Figure 2 indicates. Thus frequency-response measurements are not interrupted by periodic readjustments of the output level. Distortion (see Figure 3) is held below 0.5% from 100 Hz to 10 kHz.

The square-wave output has a very fast transition time, typically 40 nanoseconds into 50 ohms. This corresponds to the rise time of a device with a bandwidth of greater than 10 MHz; hence it is adequate for most transient-response testing. The maximum output is greater than + 5 volts peak-to-peak

¹R. E. Owen, "All-Solid-State Low Distortion Oscillator," *General Radio Experimenter*, March 1966.

²F. B. Anderson, "Seven-League Oscillator," *Proceedings of the IRE*, 39, August 1951, pp 881-890.

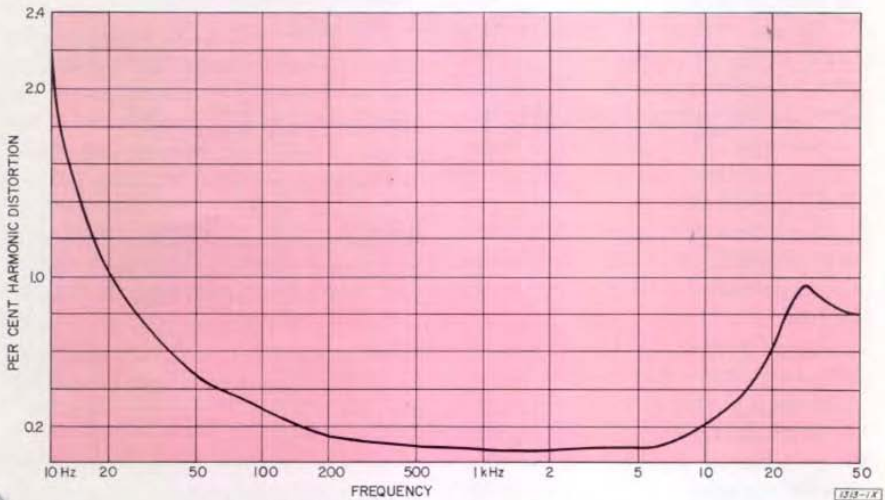

Figure 3. Typical distortion-vs-frequency characteristic.



Figure 4. In a production test, the 1313 drives a loudspeaker over the entire audio range in one turn of the dial.

(Courtesy of KLH Research and Development Co., Cambridge, Massachusetts)

(open-circuit), and it is direct-coupled, so there is no low-frequency tilt, even at 10 Hz. Symmetry is specified at $\pm 2\%$ (48%-52% duty ratio) over the whole frequency range, but typically there is no asymmetry discernible on an oscilloscope. The square-wave output can be continuously adjusted by the 20-dB attenuator.

There are no provisions for mechanically sweeping this oscillator. Sweeping an inexpensive RC oscillator of this type is not recommended because of transient amplitude changes as the frequency varies and because the dial calibration is nonlogarithmic. For sweep applications in this frequency range, we recommend the TYPE 1304-B Beat-Frequency Audio Generator, which provides logarithmic calibration and

which maintains constant amplitude when mechanically swept.

The TYPE 1313-A, in common with other General Radio RC oscillators, has a frequency-synchronization capability (see page 3). As a result of the single-range circuit, the frequency locking range varies from less than 1% per volt input at 10 Hz to greater than 40% per volt at 50 kHz. This synchronizing feature permits each station on a production line to have, in essence, a tuned isolation amplifier with independent amplitude and waveform control, operating from one standard-frequency source.

— R. E. OWEN

A biographical sketch of Mr. Owen appeared in the March 1966 *Experimenter*.

SPECIFICATIONS

FREQUENCY

Range: 10 Hz to 50 kHz in one range.

Accuracy: $\pm 4\%$ or $\pm 1\text{Hz}$, whichever is greater.

Synchronization: An external reference signal can be introduced through phone jack to phase-lock oscillator. 1-V input provides locking range of $\pm 1\%$ to $\pm 40\%$, depending on frequency.

OUTPUT

Sine Wave

Power: 10 mW into 600- Ω load.

Voltage: 5.0 V $\pm 5\%$ open-circuit.

Impedance: 600 Ω . One terminal grounded.

Control: Minimum of 20 dB continuously adjustable and 60 dB step attenuator (20 \pm 0.2 dB per step). Also, a 0-V output position with 600- Ω output impedance maintained.

Distortion: Less than 0.5% from 100 Hz to 10 kHz.

60-Hz Hum: Less than 0.05% at 1 kHz.

Frequency Characteristic: $\pm 2\%$ over whole frequency range for loads of 600 Ω or greater.

Square Wave

Voltage: Greater than +5 V p-p, open-circuit. De-coupled output.

Impedance: 600 Ω .

Rise Time: Less than 100 ns into 50 Ω . Typically 40 ns at full output.

Control: Minimum of 20 dB, continuously adjustable attenuator only.

Symmetry: $\pm 2\%$ over whole frequency range.

GENERAL

Accessories Supplied: CAP-22 Power Cord, spare fuses.

Accessories Available: 1560-P95 Adaptor Cable (phone plug to 274-MB Double Plug) for connection to synchronizing jack; relay-rack adaptor set.

Power Required: 100 to 125 V, 200 to 250 V, 50 to 400 Hz, 6 W.

Mounting: Convertible-bench cabinet.

Dimensions (width-height-depth): $8\frac{3}{16}$ by $5\frac{7}{8}$ by $8\frac{1}{8}$ in (210 by 150 by 210 mm).

Weight: Net, 7 lb (3.2 kg); shipping, $9\frac{1}{4}$ lb (4.2 kg).

Catalog Number	Description	Price in USA
1313-9701	Type 1313-A Oscillator, 10 Hz-50 kHz	\$325.00
1560-9695	Type 1560-P95 Adaptor Cable	3.00
0480-9638	Type 480-P308 Rack-Adaptor Set	7.00

HARMONIC BRIDGE USES RC-OSCILLATOR SYNCHRONIZATION

Ingenious use is made of the synchronizing capability of a GR 1310 Oscillator by Dr. Homer Fay of the Speedway Laboratories of Union Carbide Corporation, Electronics Division. Writing in *The Review of Scientific Instruments*¹, Dr. Fay describes a system used to measure linear and non-linear electric coefficients and quadratic electrooptic coefficients in high-dielec-

tric perovskite crystals. These coefficients can be derived from a capacitance-bridge measurement if the harmonic content of the driving voltage is known, and this is where the synchronizing oscillator enters the system.

The 1310, along with several other GR oscillators (see page 3, this issue), can be phase-locked to a signal whose frequency is within a certain range of the oscillator dial setting; moreover, once lock is established, the oscillator

¹ Dr. Homer Fay, "Harmonic Bridge for Measurement of Nonlinear Electric and Electrooptic Properties of Crystals," *The Review of Scientific Instruments*, February 1967.



Figure 1.
Type 1310 Oscillator.

frequency control can be used as a phase shifter, over a range of $\pm 75^\circ$ or so.

In Dr. Fay's setup (Figure 2), the oscillator frequency dial of each of several 1310 oscillators is set in the vicinity of a harmonic of the driving signal, thereby establishing lock. The oscillators then assume control of both the phase (by means of the frequency control) and the amplitude (by means of the output level control) of each harmonic covered. The phase and amplitude of these harmonic components are adjusted to cancel the harmonics created by the nonlinearity

of the crystal under test. Finally, measurements of the amount of such compensation at each harmonic are used to calculate the electric coefficients of the crystal.

Such measurements are important because many effects in crystals are directly related to electric displacement. The electrooptic effect is an example. The harmonic bridge, says Dr. Fay, "permits display of the electrically induced phase retardation intensity pattern as a function of electric displacement, from which the electrooptic coefficients may be readily obtained."

— R. E. ANDERSON

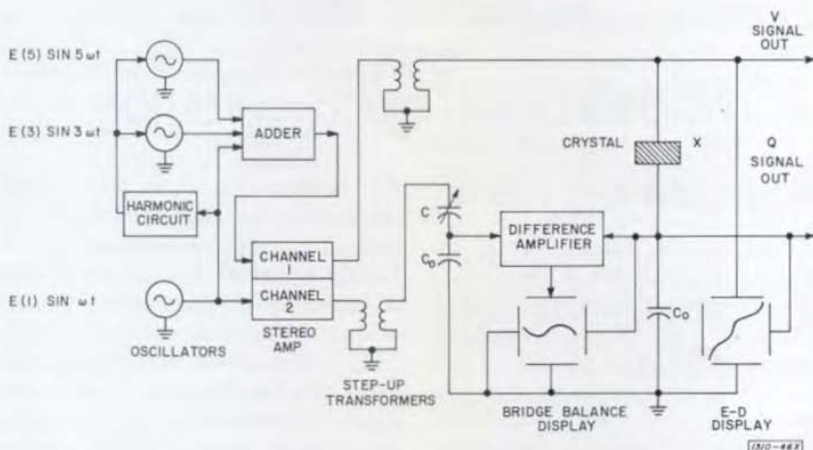

Figure 2. Block diagram of harmonic bridge, showing use of GR 1310 Oscillators to provide harmonics of driving signal.



Figure 1. Type 1232-P2 Pre-amplifier attached to the 1232-A Tuned Amplifier and Null Detector

A PREAMP FOR USE WITH BRIDGE DETECTORS

In the quest for low noise in an amplifier, one must accept the fact that no one amplifying device is optimum for signal sources of widely differing impedance levels. Some compromise is therefore inevitable in the design of the input stage of a sensitive null detector that is to be used in a variety of applications. The low-noise transistor used in the TYPE 1232-A Tuned Amplifier and Null Detector¹ is suitable for use with most impedance-bridge sys-

tems. However, some measurements requiring extremely high sensitivity present a very high impedance to the detector, and in such cases the detector could benefit from a preamplifier with a very high optimum-source resistance. The new 1232-P2 FET Preamplifier (Figure 1), designed to fill this need, can increase sensitivity by a factor of 10 or more in some measurements.

Plots of typical equivalent input noise vs resistance for the 1232-A alone and with the 1232-P2 are shown in Figure 2. The input noise can be char-

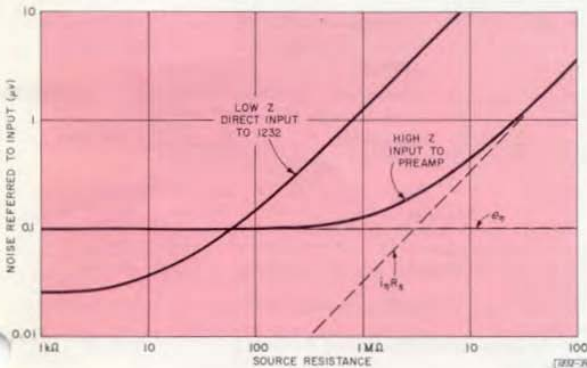

Figure 2. Equivalent input noise vs source resistance for 1232-A alone and for combination of 1232-A and 1232-P2.

¹A. E. Sanderson, "A Tuned Amplifier and Null Detector with One-Microvolt Sensitivity," *General Radio Experimenter*, July 1961.

acterized by an equivalent voltage noise generator, e_n , and a current noise generator, i_n . On the plot of equivalent input noise voltage vs resistance, e_n is a horizontal line and $i_n \times R_s$ is a diagonal line. Note that the two curves cross at 60 kilohms and that below this value the 1232-A is better without the preamplifier.

One application where the addition of the preamplifier is a distinct advantage is the measurement of low-loss dielectric samples on the GR 1615-A Capacitance Bridge. Here the unknown capacitance is usually less than 1000 pF, the lowest D range is usually used (and not the G ranges), and the frequency is usually under 500 Hz. On the lowest D range, the output capacitance of the 1615-A is approximately 1600 pF + C_z + cable capacitance. If C_z and the cable capacitance are small, the output impedance will be about 1 M Ω at 100 Hz, and the preamplifier will improve sensitivity by a factor of about 10, as shown by Figure 2. As the frequency increases, the impedance decreases, and eventually the 70-pF capacitance of the preamplifier's input

cable negates the use of the preamplifier, even with a source of infinite impedance.

The preamplifier is of no advantage on the higher D range, where bridge capacitance is 10 times as great as on the lowest D range, or on the G ranges, where the output impedance is shunted by 100 kilohms.

The circuit of the preamplifier consists of a single source-follower stage, using a field-effect transistor. A switch allows the user to bypass the preamplifier in applications where the 1232-A is better off alone. The preamplifier is housed in a thin "pancake" box that is easily added to the side of the 1232-A or between the 1311-A Oscillator and the 1232-A in assemblies. The resulting combinations are available as the TYPES 1232-AP (1232-A plus preamplifier) and 1240-AP (1232-A plus preamplifier plus 1311-A). The entire TYPE 1620 Capacitance Measuring Assembly, when supplied with the preamplifier, is designated TYPE 1620-AP.

— H. P. HALL

SPECIFICATIONS

Input Impedance: Greater than 100 M Ω in parallel with 70 pF.

Output Impedance: 10 k Ω .

Voltage Gain: Approx 0.7.

Noise (referred to input): Open-circuit equivalent, 0.1 pA; short-circuit equivalent, 0.3 μ V (when used with Type 1232-A tuned to 100 Hz).

Optimum Source Impedance: 3 M Ω .

Connectors: GR874 on cables, input and output.
Power Required: 12 V, 200 μ A, supplied by 1232-A.

Dimensions (width-height-depth): $\frac{3}{4}$ by 6 by $7\frac{1}{2}$ in (20 by 150 by 190 mm).

Weight: Net, 15 oz (425 grams); **shipping, (est)** 3 lb (1.4 kg).

Catalog Number	Description	Price in USA
1232-9602	Type 1232-P2 Preamplifier	\$ 95.00
1232-9829	Type 1232-AP Tuned Amplifier and Null Detector, with preamplifier	485.00
1240-9829	Type 1240-AP Bridge Oscillator-Detector, with preamplifier	725.00
1620-9829	Type 1620-AP Capacitance-Measuring Assembly, with preamplifier	2325.00



Type 1123 Digital Synchronometer.

SYNCHRONOMETER WITH 1-2-4-8 CODE

A new version of the SYNCHRONOMETER® digital time comparator¹ is now available. The output impedance of the new model has been lowered by a factor of 10, and the output coding has been changed to 1-2-4-8 BCD. All other features of the instrument — standby battery power, synchronization capability, fail-safe operation, etc — remain unchanged.

In the new instrument, a buffer transistor is added to each of the 44 data-output lines, reducing the output

impedance and permitting the change in coding. Rise times of the data output are thus reduced, simplifying the transfer of precise time data to a parallel-storage unit, printer, or computer.

¹D. O. Fisher and R. W. Frank, "A New Approach to Precision Time Measurements," *General Radio Experimenter*, February-March 1965.

SPECIFICATIONS

Same as 1123-A¹, except as follows:

Time-of-day Data Output:

From all decades, parallel 1-2-4-8 BCD

Logic 0: approx 0.8 V, impedance 1 kΩ.

Logic 1: approx 15 V, impedance 11 kΩ.

Catalog Number	Description	Price in USA
1123-9760	Type 1123 Digital Synchronometer (1-2-4-8 BCD Code), 115 V, Bench Model	\$3450.00
1123-9763	Type 1123 Digital Synchronometer (1-2-4-8 BCD Code), 115 V, Rack Model	3450.00
1123-9762	Type 1123 Digital Synchronometer (1-2-4-8 BCD Code), 230 V, Bench Model	3450.00
1123-9765	Type 1123 Digital Synchronometer (1-2-4-8 BCD Code), 230 V, Rack Model	3450.00

QUANTITY PRICES FOR ENLARGED SMITH CHARTS

Since some users of the new enlarged Smith Charts (22½" × 35") announced in September want to order more than one pad at a time, and we are happy to handle the larger orders, the following quantity price schedule has been established.

Number of Pads	Price per Pad of 75 Sheets
1	\$6.00
2-3	5.75
4-9	5.50
10-19	5.00
20 and up	4.75



GENERAL RADIO COMPANY
WEST CONCORD, MASSACHUSETTS 01781

DO WE HAVE YOUR CORRECT NAME AND ADDRESS—name, company or organization, department, street or P.O. box, city, state, and zip code? If not, please clip the address label on this issue and return it to us with corrections, or if you prefer, write us; a postcard will do.



Experimenter INDEX

An index to the *Experimenter* for the year 1966 is now available free on request. Binders to accommodate about two years' copies are also available at no charge. Write to Editor, General Radio Experimenter, General Radio Company, West Concord, Massachusetts 01781.

GENERAL RADIO COMPANY
WEST CONCORD, MASSACHUSETTS 01781