

## SRX Series

# Resistance Standard Operation Manual





---

**IET LABS, INC.**

**[www.ietlabs.com](http://www.ietlabs.com)**  
Email: [info@ietlabs.com](mailto:info@ietlabs.com)  
TEL: (516) 334-5959 • FAX: (516) 334-5988



---

**IET LABS, INC.**

**[www.ietlabs.com](http://www.ietlabs.com)**  
Email: [info@ietlabs.com](mailto:info@ietlabs.com)  
TEL: (516) 334-5959 • FAX: (516) 334-5988



---

**IET LABS, INC.**

**[www.ietlabs.com](http://www.ietlabs.com)**  
Email: [info@ietlabs.com](mailto:info@ietlabs.com)  
TEL: (516) 334-5959 • FAX: (516) 334-5988

## SRX/SRC Series

### Resistance Standard User and Service Manual



Copyright © 2019 IET Labs, Inc.  
Visit [www.ietlabs.com](http://www.ietlabs.com) for manual revision updates

SRX/SRC im/January 2019

◆ PRECISION INSTRUMENTS FOR TEST AND MEASUREMENT ◆

## **WARRANTY**

We warrant that this product is free from defects in material and workmanship and, when properly used, will perform in accordance with applicable IET specifications. If within one year after original shipment, it is found not to meet this standard, it will be repaired or, at the option of IET, replaced at no charge when returned to IET. Changes in this product not approved by IET or application of voltages or currents greater than those allowed by the specifications shall void this warranty. IET shall not be liable for any indirect, special, or consequential damages, even if notice has been given to the possibility of such damages.

**THIS WARRANTY IS IN LIEU OF ALL OTHER WARRANTIES, EXPRESSED OR IMPLIED, INCLUDING BUT NOT LIMITED TO, ANY IMPLIED WARRANTY OF MERCHANTABILITY OR FITNESS FOR ANY PARTICULAR PURPOSE.**

# Safety Symbols

General definitions of safety symbols used on the instrument or in manuals are listed below.



Caution symbol: the product is marked with this symbol when it is necessary for the user to refer to the instruction manual.



Hazardous voltage symbol: the product is marked with this symbol when high voltage maybe present on the product and an electrical shock hazard can exist.



Indicates the grounding protect terminal, which is used to prevent electric shock from the leakage on chassis. The ground terminal must connect to earth before using the product



Direct current.



Alternating current.



Frame or chassis terminal. A connection to the frame (chassis) of the equipment which normally includes all exposed metal structures.



On supply.



Off supply.



Hot surface. Avoid contact. Surfaces are hot and may cause personal injury if touched.



Waste Electrical and Electronic Equipment (WEEE) Directive 2002/96/EC

This product complies with the WEEE Directive (2002/96/EC) marking requirements.

The affixed label indicates that you must not discard this electrical/ electronic product in domestic household waste.

Product Category: With reference to the equipment types in the WEEE directive Annex 1, this product is classified as a “Monitoring and Control instrumentation” product.



Do not dispose of electrical appliances as unsorted municipal waste, use separate collection facilities.

Contact your local government for information regarding the collection systems available. If electrical appliances are disposed of in landfills or dumps, hazardous substances can leak into the groundwater and get into the food chain, damaging your health and well-being.

When replacing old appliances with new one, the retailer is legally obligated to take back your old appliances for disposal.

## Proposition 65 Warning for California Residents

 **WARNING:** Cancer and Reproductive Harm - [www.P65Warnings.ca.gov](http://www.P65Warnings.ca.gov).

This product may contain chemicals known to the State of California to cause cancer, birth defects, or other reproductive harm



## **SAFETY PRECAUTIONS**

The following general safety precautions must be observed during all phases of operation, service, and repair of this instrument. Failure to comply with these precautions or with specific WARNINGS elsewhere in this manual may impair the protection provided by the equipment. Such noncompliance would also violate safety standards of design, manufacture, and intended use of the instrument.

IET Labs assumes no liability for the customer's failure to comply with these precautions.

This is an indoor use product.

### DANGEROUS PROCEDURE WARNINGS

Comply with all WARNINGS - Procedures throughout in this manual and instructions on the instrument prevent you from potential hazard. These instructions contained in the warnings must be followed.

#### BEFORE APPLYING POWER

Verify that all safety precautions are taken. Make all connections to the instrument before applying power. Note the instrument's external markings described under "Safety Symbols".

- DO NOT Operate in an Explosive Atmosphere
- Do not operate the instrument in the presence of inflammable gasses or fumes
- Operation of any electrical instrument in such an environment clearly constitutes a safety hazard
  - Use Caution around live circuits and whenever hazardous voltages > 45 V are present
  - Operators must not remove instrument covers
  - Component replacement and internal adjustments must be made by qualified maintenance personnel only
- DO NOT substitute parts or modify the instrument
  - When working with high voltages; post warning signs, train personnel and keep unauthorized personnel away.

To avoid the danger of introducing additional hazards, do not install substitute parts or perform unauthorized modifications to the instrument.

Return the instrument to an IET Labs for service and repair to ensure that safety features are maintained in operational condition.



## **WARNING**



OBSERVE ALL SAFETY RULES  
WHEN WORKING WITH HIGH VOLTAGES OR LINE VOLTAGES.

**Dangerous voltages may be present inside this instrument. Do not open the case  
Refer servicing to qualified personnel**

### **HIGH VOLTAGES MAY BE PRESENT AT THE TERMINALS OF THIS INSTRUMENT**

WHENEVER HAZARDOUS VOLTAGES (> 45 V) ARE USED, TAKE ALL MEASURES TO  
AVOID ACCIDENTAL CONTACT WITH ANY LIVE COMPONENTS.

USE MAXIMUM INSULATION AND MINIMIZE THE USE OF BARE  
CONDUCTORS WHEN USING THIS INSTRUMENT.

**Use extreme caution when working with bare conductors or bus bars.**

WHEN WORKING WITH HIGH VOLTAGES, POST WARNING SIGNS AND  
KEEP UNREQUIRED PERSONNEL SAFELY AWAY.



## **CAUTION**



DO NOT APPLY ANY VOLTAGES OR CURRENTS TO THE TERMINALS OF THIS  
INSTRUMENT IN EXCESS OF THE MAXIMUM LIMITS INDICATED ON  
THE FRONT PANEL OR THE OPERATING GUIDE LABEL.

# Contents

<i>Chapter 1 Introduction</i> .....	1
1.1 <i>Introduction</i> .....	1
<i>Chapter 2 Specifications</i> .....	2
<i>Specifications</i> .....	2
<i>Label</i> .....	4
<i>Chapter 3 Operation</i> .....	6
3.1 <i>Initial Inspection and Setup</i> .....	6
3.2 <i>Connections</i> .....	6
3.2.1 <i>Connections for values <math>\leq 190\text{ k}\Omega</math></i> .....	6
3.2.2 <i>Connections for values <math>&gt; 190\text{ k}\Omega</math> and <math>&lt; 100\text{ M}\Omega</math></i> .....	6
3.2.3 <i>Connections for values <math>\geq 100\text{ M}\Omega</math></i> .....	7
3.3 <i>Thermal emf Considerations</i> .....	7
3.4 <i>Environmental Conditions</i> .....	7
3.4.1 <i>Operating Temperature</i> .....	7
3.4.2 <i>Storage Temperature</i> .....	7
3.5 <i>Shipping and Handling</i> .....	7
<i>Chapter 4 Maintenance</i> .....	8
4.1 <i>Maintainability and Reliability</i> .....	8
4.2 <i>Preventive Maintenance</i> .....	8
4.3 <i>Calibration</i> .....	8
4.3.1 <i>Calibration Interval</i> .....	8
4.3.2 <i>General Considerations</i> .....	8
4.3.3 <i>Required Equipment</i> .....	9
4.3.4 <i>Calibration Procedure</i> .....	9
4.4 <i>Replaceable Parts List</i> .....	9

## Figures and Tables

<i>Figure 1-1: SRX Series Resistance Standard</i> .....	1
<i>Table 2-1: SRX Specifications</i> .....	2
<i>Table 2-2: SRC Specifications</i> .....	2
<i>Figure 2-1: Sample label affixed to unit</i> .....	3
<i>Figure 3-1: Connections for values <math>\leq 190\text{ k}\Omega</math></i> .....	6
<i>Table 3-1: Connections for values <math>\leq 190\text{ k}\Omega</math></i> .....	6
<i>Figure 3-2: Connections for values <math>&gt; 190\text{ k}\Omega</math> and <math>&lt; 100\text{ M}\Omega</math></i> .....	6
<i>Table 3-2: Connections for values <math>&gt; 190\text{ k}\Omega</math> and <math>&lt; 100\text{ M}\Omega</math></i> .....	6
<i>Figure 3-3: Connections for values <math>\geq 100\text{ M}\Omega</math></i> .....	7
<i>Table 3-3: Connections for values <math>\geq 100\text{ M}\Omega</math></i> .....	7
<i>Table 4-1: Replaceable Parts List</i> .....	9
<i>Figure 4-1: SRX/SRC Replaceable Parts</i> .....	9

# Chapter 1

## INTRODUCTION

### 1.1 Introduction

The SRX/SRC Series (Figure 1.1) are stable, laboratory or portable resistance standards. Their ruggedness and small size plus their low temperature coefficient makes the SRX/SRC Series ideal for any applications outside of laboratory environment within the temperature range of 18°C to 28°C. Because of the low temperature coefficient, they require no oil-temperature bath.

The SRX series units are available in values ranging from 1 mΩ to 100 MΩ, with custom values available, to satisfy any requirement. The SRX series feature excellent stability and low temperature coefficient.

The SRC series units are available in resistance values form 190 MΩ to 10 TΩ. The SRC Series are designed for operation up to 5000 V dc.

To reduce errors caused by temperature changes, the SRX/SRC units are built with a low temperature coefficient at 23°C.

The 5-way binding posts are constructed of low-thermal emf material.



**Figure 1-1: SRX Series Resistance Standard**

## Chapter 2

# SPECIFICATIONS

For convenience to the user, the pertinent specifications are given in an **OPERATION GUIDE**, shown in Figures 2-1.

Model SRX-	Nominal (Ω)	Initial Adjustment to Nominal (ppm)	Stability 1 year (ppm)	Tempco (ppm/°C)	Resistor type	Max. Power* (W)	Power Coef.** (ppm/mW)	Max. Voltage (V)	Max. Current (A)	Terminals	
0.001	0.001	200	50	20	Manganin strip	0.2	0.1	0.015	14 A	4 bp's + gnd	
0.0019	0.0019	200	50	20		0.38	0.1	0.03	14 A		
0.002	0.002	200	50	20		0.4	0.1	0.02	14 A		
0.01	0.01	200	50	20		0.2	0.1	0.15	4.5 A		
0.019	0.019	200	50	20	Manganin wire	0.38	0.1	0.3	4.5 A		
0.1	0.1	200	50	20		0.2	0.1	0.3	1.4 A		
0.19	0.19	200	50	20	Hermetically sealed wire-wound	0.38	0.1	0.6	1.4 A		
1	1	20	20	10		0.25	0.5	0.5	0.5 A		
1.9	1.9	20	20	10		0.25	0.5	0.7	0.36 A		
10	10	10	10	3		0.1	0.15	1	0.1 A		
19	19	10	10	3		0.1	0.15	1.4	70 mA		
50	50	10	10	1		0.1	0.05	2.3	45 mA		
100	100	10	10	1		0.1	0.05	3	30 mA		
190	190	10	10	1		0.1	0.05	4.4	23 mA		
1K	1 k	10	10	1		0.1	0.05	10	10 mA		
1.9K	1.9 k	10	10	1		0.1	0.05	14	7 mA		
10K	10 k	10	10	1		0.1	0.05	30	3 mA		
19K	19 k	10	10	1		0.1	0.05	43	2.2 mA		
100K	100 k	10	10	1		0.1	0.05	100	1 mA		
190K	190 k	10	10	1		0.1	0.05	140	0.7 mA		
1M	1 M	20	15	3		0.1	0.15	316	0.3 mA		
1.9M	1.9 M	20	15	3		0.1	0.15	440	0.23 mA		
10M	10 M	20	20	5		0.1	0.25	2000	0.1 mA		
19M	19 M	20	20	5		0.05	0.7	5000	50 μA		
100M	100 M	50	20	5		Precision thick film resistors sealed in a case	0.01	1.2	5000	10 μA	2 bp's + gnd and guard

\*Maximum Power is specified for no change in resistance value beyond stated stability. See \*\*Power Coefficient note for maximum rated power.

\*\*Power Coefficient: SRX units with hermetically sealed wirewound resistors have a maximum rated power of 1.0 W. Operation at values higher than 0.1 W will cause self-heating effects on the order of 50 °C/W, assuming a 23°C ambient temperature. This will cause a reversible change in resistance beyond stated stability.

**Table 2-1: SRX Specifications**

Model SRC-	Nominal (Ω)	Initial Adjustment to Nominal (ppm)	Stability 1 year (ppm)	Tempco (ppm/°C)	Resistor type	Max. Voltage (V)	Terminals
190M	190 M	0.1%	500	25	Precision thick film resistor sealed in a case	5000	2 bp's + gnd and guard
1G	1 G	0.5%	500	50			
1.9G	1.9 G	0.5%	500	50			
10G	10 G	0.5%	500	50			
19G	19 G	0.5%	500	50			
100G	100 G	0.5%	500	50			
190G	190 G	1%	500	50			
1T	1 T	2%	500	100			
1.9T	1.9 T	2%	1000	200			
10T	10 T	3%	2000	300			

**Table 2-2: SRC Specifications**

**Calibration Conditions:**

At 23°C, low power, traceable to SI

**Terminals:**

Gold-plated, tellurium-copper, low-thermal-emf binding posts on standard 3/4 inch spacing. A GROUND terminal is provided on all units.

≤190 kΩ: four 5-way binding posts for 4-terminal measurement

1 MΩ ≤ 19 MΩ: two 5-way binding posts

≥100 MΩ two 5-way binding posts plus GUARD terminal

**Transit Case:**

Optional Model SRC-100 lightweight transit case with handle, suitable for transporting and storing two units. The case provides mechanical protection and insulation from temperature changes during transportation or shipping.

**Dimensions:**

8.6 cm H x 10.5 cm W x 12.7 cm D (3.4" x 4.15" x 5")

**Weight:**

0.73 kg (1.6 lb)

**SRX Series RESISTANCE STANDARD**

 **Stability:** 20 ppm/year  
**Maximum Power:** 0.25 W  
**Cert No:** 2073.01 **Temp. Coefficient:** 10 ppm/°C  
**Power Coefficient:** 0.5 ppm/mW  
**Temperature Range:** 15°C to 30°C  
**Storage Temperature:** 0°C to 40°C

---

**REPORT #: 82893**  
**Tech:** CTS **Date:** 21-Oct-2015  
**Temp(°C):** 23.5 **Due:**

---

**Calibrated Resistance (R)**  
**999.996 48 mΩ**  
Meas. Uncertainty: 9.6 ppm

---

**Model:** SRX-1 **SN:** J1-XXXXXXXX

---

 **IET LABS, INC.** Long Island, NY  
Email: info@ietlabs.com · Tel: 516-334-5959  
www.ietlabs.com

Figure 1-1: Typical Operating Guide Affixed to Unit



# Chapter 3 OPERATION

## 3.1 Initial Inspection and Setup

This instrument was carefully inspected before shipment. It should be in proper electrical and mechanical order upon receipt.

An **OPERATION GUIDE** is attached to the case of the instrument to provide ready reference to specifications.

## 3.2 Connections

The SRX/SRC series has three different types of connections listed below.

### 3.2.1 Connections for values $\leq 190\text{ k}\Omega$

Values  $\leq 190\text{ k}\Omega$  have four insulated low thermal emf binding posts for four-terminal measurements as shown in Figure 3-1. The fifth binding post **GND** is connected to the case. For high-resistance models (e.g.  $>10\text{ k}\Omega$ ) two-terminal measurements may be made by shorting **HI** to **HI** and **LO** to **LO**, preferably with shorting links or other substantial means.

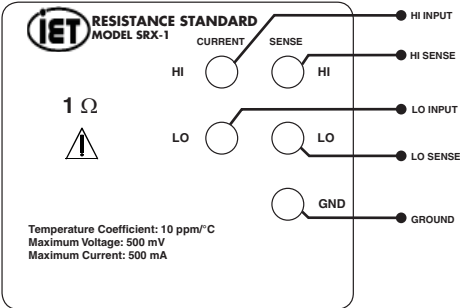

Figure 3-1: Connections for values  $\leq 190\text{ k}\Omega$

Binding Post	Function
CURRENT HI	Current input from source (e.g. ohmmeter)
CURRENT LO	Current return to source (e.g. ohmmeter)
SENSE HI	Measurement point for a four-wire ohmmeter
SENSE LO	Measurement point for a four-wire ohmmeter
GND	Guard or shield

Table 3-1: Connections for values  $\leq 190\text{ k}\Omega$

### 3.2.2 Connections for values $> 190\text{ k}\Omega$ and $< 100\text{ M}\Omega$

Values  $> 190\text{ k}\Omega$  and  $< 100\text{ M}\Omega$  have two insulated, low thermal emf binding posts for two-terminal measurements as shown in Figure 3-2. The third binding post **GND** is connected to the case.

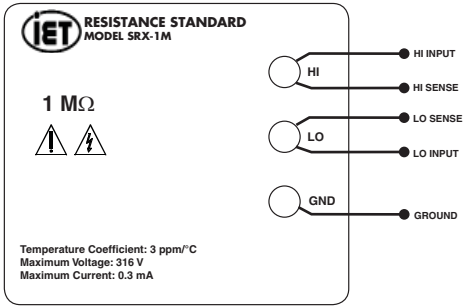

Figure 3-2: Connections for values  $> 190\text{ k}\Omega$  and  $< 100\text{ M}\Omega$

Binding Post	Function
HI	Input from source (e.g. ohmmeter)
LO	Measurement point
GND	Guard or shield

Table 3-2: Connections for values  $> 190\text{ k}\Omega$  and  $< 100\text{ M}\Omega$

### 3.2.3 Connections for values $\geq 100\text{ M}\Omega$

Values  $\geq 100\text{ M}\Omega$  have two insulated, low thermal emf binding posts for two-terminal measurements as shown in Figure 3-3. The third binding post, labeled **GROUND**, is connected to the case. The fourth binding post, labeled **GUARD**, is connected to an internal case that contains the resistor.

Use of the **GUARD** terminal provides the best accuracy when measuring high resistance by minimizing unwanted leakage between **HI** and **LO** terminals.

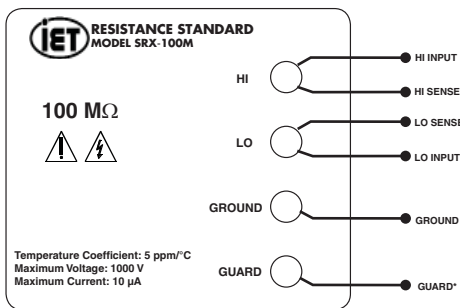

\*If no GUARD point exists on the measuring instrument, it may be connected to GROUND.

Figure 3-3: Connections for values  $\geq 100\text{ M}\Omega$

Binding Post	Function
HI	Input from source (e.g. ohmmeter)
LO	Measurement point
GROUND	Shield
GUARD	Interrupts leakage from the internal resistor to the case and other components of the unit

Table 3-3: Connections for values  $\geq 100\text{ M}\Omega$

### 3.3 Thermal emf Considerations

High-quality, gold-plated, tellurium-copper binding posts serve to minimize the thermal emf effects which would artificially reflect a change in dc resistance measurements. All other conductors within the instrument, as well as the solder used, contain no metals or junctions that could contribute to thermal emf problems.

There nevertheless may be some minute thermal emf generated at the test leads where they contact the gold banana jacks. This voltage will also be eliminated if a meter with so called “True Ohm” capability is used. Otherwise the generated emf may represent itself as a false component of the dc resistance measurement.

Always use low emf test leads when working with SRX/SRC models. In particular, avoid brass or steel conductors.

### 3.4 Environmental Conditions

#### 3.4.1 Operating Temperature

For optimal accuracy, SRX/SRC Models should be used in an environment of 23°C. They should be allowed to stabilize at those temperatures after any significant temperature variation.

#### 3.4.2 Storage Temperature

The SRX/SRC Series should be maintained within the storage temperature range of 0°C to 40°C to retain its accuracy within the specified limits.

### 3.5 Shipping and Handling

The SRX/SRC Series should not be exposed to any excessive shock or temperature extremes. The option SRC-100, a lightweight transit case capable of storing two SRX/SRC units, is recommended for shipping or transporting the models.

# Chapter 4

## MAINTENANCE

### 4.1 Maintainability and Reliability

It is possible to maintain SRX/SRC units indefinitely. They are reliable due to their closed, rugged design and sealed resistors. The units are resistant to electromagnetic interference (EMI) because of their metal enclosure.

### 4.2 Preventive Maintenance

Keep the SRX/SRC units in a clean environment. This will help prevent possible contamination.

The front panel may be cleaned to eliminate any leakage paths from near or around the binding posts. To clean the front panel:

Wipe the front panel clean using alcohol and a lint-free cloth.

### 4.3 Calibration

The SRX/SRC units may be employed as stand-alone instruments or as an integral components of a system. If used as part of a system, they should be calibrated as part of the overall system to provide an optimum system calibration.

If an SRX/SRC model is employed as a stand-alone device, the following should be observed:

- Calibration Interval
- General Considerations
- Required Equipment
- Calibration Procedure

### 4.3.1 Calibration Interval

The recommended SRX/SRC Series calibration interval is twelve (12) months.

If the instrument is used to transfer resistance values only, recalibration is not required, assuming that there has been no drastic change of value.

### 4.3.2 General Considerations

Before starting the calibration procedure, you need to consider the following:

- Calibration environment should be 23°C and less than 50% relative humidity.
- Test instruments should be sufficiently more accurate than the SRX/SRC unit, and/or the uncertainty of the measurement instrumentation has to be considered in the calibration Test Uncertainty Ratio (TUR).
- The testing equipment and the SRX/SRC unit should stabilize at laboratory conditions for at least 24 hours.
- Kelvin type 4-wire test leads should be used to obtain accurate low resistance measurements.
- Steps should be taken to minimize thermal emf effects, such as using a meter with “True Ohm” capacity.
- Accepted metrology practices should be followed.

### 4.3.3 Required Equipment

Many combinations of standards, transfer standards, meters, and bridges may be used to calibrate this instrument. The following are some possible choices:

- Resistance Standards or Transfer Standards for the required values with traceable calibrations, such as the following standards available from IET Labs
  - SR-102 100  $\Omega$
  - SR-103 1 k $\Omega$
  - SR-104 10 k $\Omega$
  - SRL series
- Precision resistance measurement bridge or multimeter, with a transfer accuracy of  $\pm 1$  ppm. Options include:
  - Guildline Model 9975
  - Measurements International Model 6010C
  - ESI model 242, 242A, 242C, or 242D
  - A high-precision, high-stability digital multimeter (e.g. Fluke 8508A) along with a set of resistance standards for ratio mode.

### 4.3.4 Calibration Procedure

To calibrate an SRX/SRC unit, proceed as follows:

1. Set up the calibration equipment in the resistance measurement mode.
2. Confirm the resistance of the unit.
3. Confirm that the resistance is consistent with historical measurements.

### 4.4 Replaceable Parts List

Reference	IET Pt No	Description
1	BP-1000-RD	Binding Post, Red
2	BP-1000-BK	Binding Post, Black
3	BP-1000-GN	Binding Post, Green
4	BP-1000-BL	Binding Post, Blue
<b>Not Shown</b>	SRX-*Res	SRX resistor assembly
<i>Replace * with nominal resistance value</i>		

Table 4-1: Replaceable Parts List

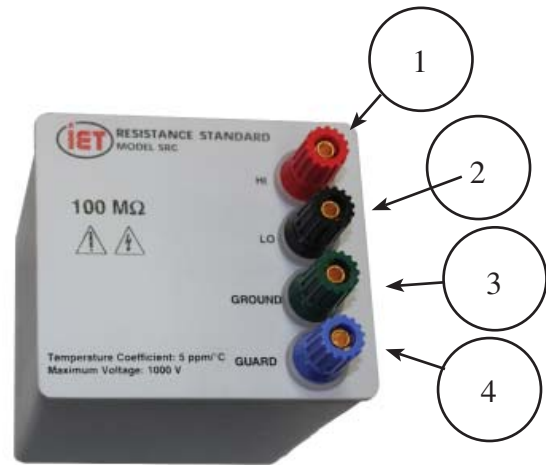

Figure 4-1: SRX/SRC Replaceable Parts

